

Uninsulated end terminals 0.25 - 50 mm²

B1,5-20ET

- Material: Cu 99.95%, tin plated Cu/Sn, CSA approved.

Uninsulated end terminal, 1.5 mm². Used with certified tool PEB0110T.

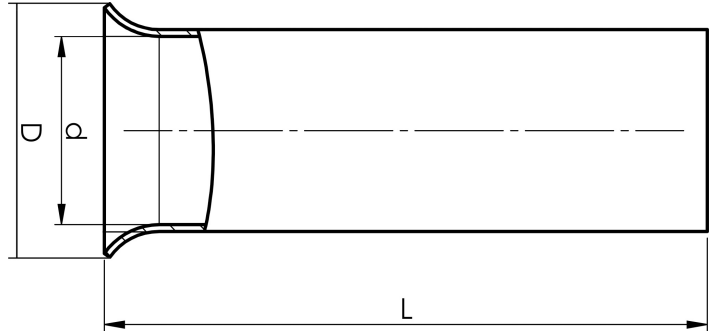

Item number: **7304-012600**

EAN: **7393487046528**

d (mm): **1.7**

D (mm): **2,8**

L (mm): **20**

s (mm): **20**

Working temperature, Min (°C): **-40**

Working temperature, Max (°C): **40**

Material: **Cu, Cu/Sn**

AWG/MCM Cu: **16 AWG**

mm² Cu: **1,5**