

KRD tube terminals 16 - 1000 mm<sup>2</sup>

# KRD630-16

- Material: Cu 99.95%, tin plated Cu/Sn.
- Inspection hole.
- For stranded (class 2) Cu conductors.

## Example of marking KRD: 14 (neck) Elpress logotype 70 10 (palm)

14 = Die No. 70 = mm<sup>2</sup> 10 = palm hole for M10  
Tube terminal type KRD for stranded (class 2) Cu  
conductors, 630 mm<sup>2</sup>, with an M16 hole in the palm.  
Used with Elpress certified systems V250 or V1470.

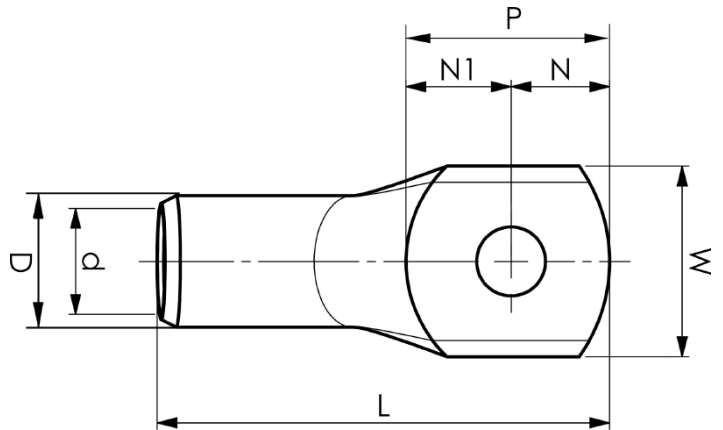

Item number: **7301-457200**

EAN: **7393487076471**

W (mm): **65**

t (mm): **10.8**

N (mm): **25**

N1 (mm): **35**

P (mm): **60**

f (mm): **1.5**

d (mm): **34**

D (mm): **45**

L (mm): **150**

s (mm): **70**

Screw: **M16**

Inspection hole: **Yes**

AWG/MCM Cu: **1250 MCM**

mm<sup>2</sup> Cu: **630**