

KRD tube terminals 16 - 1000 mm<sup>2</sup>

# KRD95-10

- Material: Cu 99.95%, tin plated Cu/Sn.
- Inspection hole.
- For stranded (class 2) Cu conductors.

## Example of marking KRD: 14 (neck) Elpress logotype 70 10 (palm)

14 = Die No. 70 = mm<sup>2</sup> 10 = palm hole for M10  
Tube terminal type KRD for stranded (class 2) Cu conductors, 95 mm<sup>2</sup>, with an M10 hole in the palm.  
Used with Elpress certified systems V600, V1300 or V250.

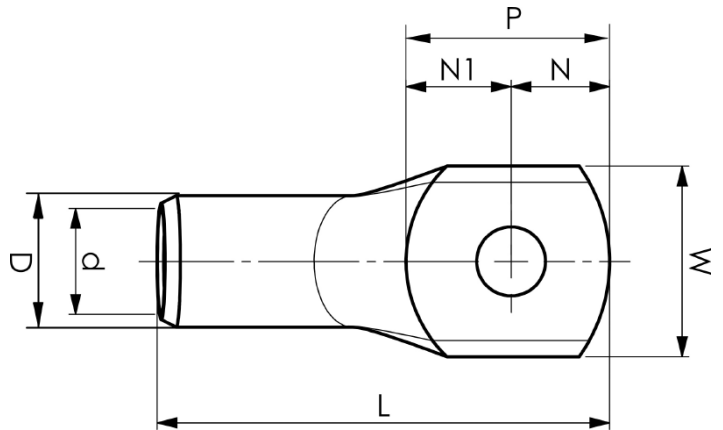

Item number: **7301-101700**

EAN: **7393487006782**

W (mm): **24**

t (mm): **2.9**

N (mm): **11**

N1 (mm): **11**

P (mm): **22**

f (mm): **1**

d (mm): **13**

D (mm): **16**

L (mm): **58**

s (mm): **26**

Screw: **M10**

Inspection hole: **Yes**

AWG/MCM Cu: **3/0 AWG**

mm<sup>2</sup> Cu: **95**