

KRD tube terminals 16 - 1000 mm²

KRD16-5

- Material: Cu 99.95%, tin plated Cu/Sn.
- Inspection hole.
- For stranded (class 2) Cu conductors.

Example of marking KRD: 14 (neck) Elpress logotype 70 10 (palm)

14 = Die No. 70 = mm² 10 = palm hole for M10
Tube terminal type KRD for stranded (class 2) Cu
conductors, 16 mm², with an M5 hole in the palm.
Used with Elpress certified systems V600, V1300 or
V250.

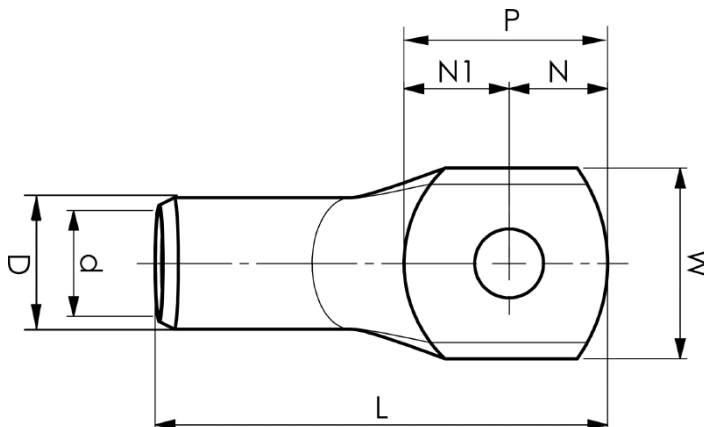

Item number: **7301-100100**

EAN: **7393487006638**

W (mm): **12**

t (mm): **2.5**

N (mm): **6**

N1 (mm): **8**

P (mm): **14**

f (mm): **1**

d (mm): **5.4**

D (mm): **8**

L (mm): **29**

s (mm): **10**

Screw: **M5**

Inspection hole: **Yes**

AWG/MCM Cu: **6 AWG**

mm² Cu: **16**